

TECHNICAL DATA

Model : GROOVE SHELF

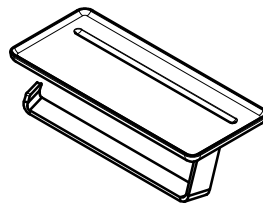

- . 이 제품은 국내용(대한민국)입니다.
- . 시공도 안의 그림은 설명을 위해 그려진 것으로 실제의 모양과 부분적으로 다를 수 있습니다.
- . 제품의 품질향상을 위하여 내/외관이 예고없이 일부 변경될 수 있습니다.

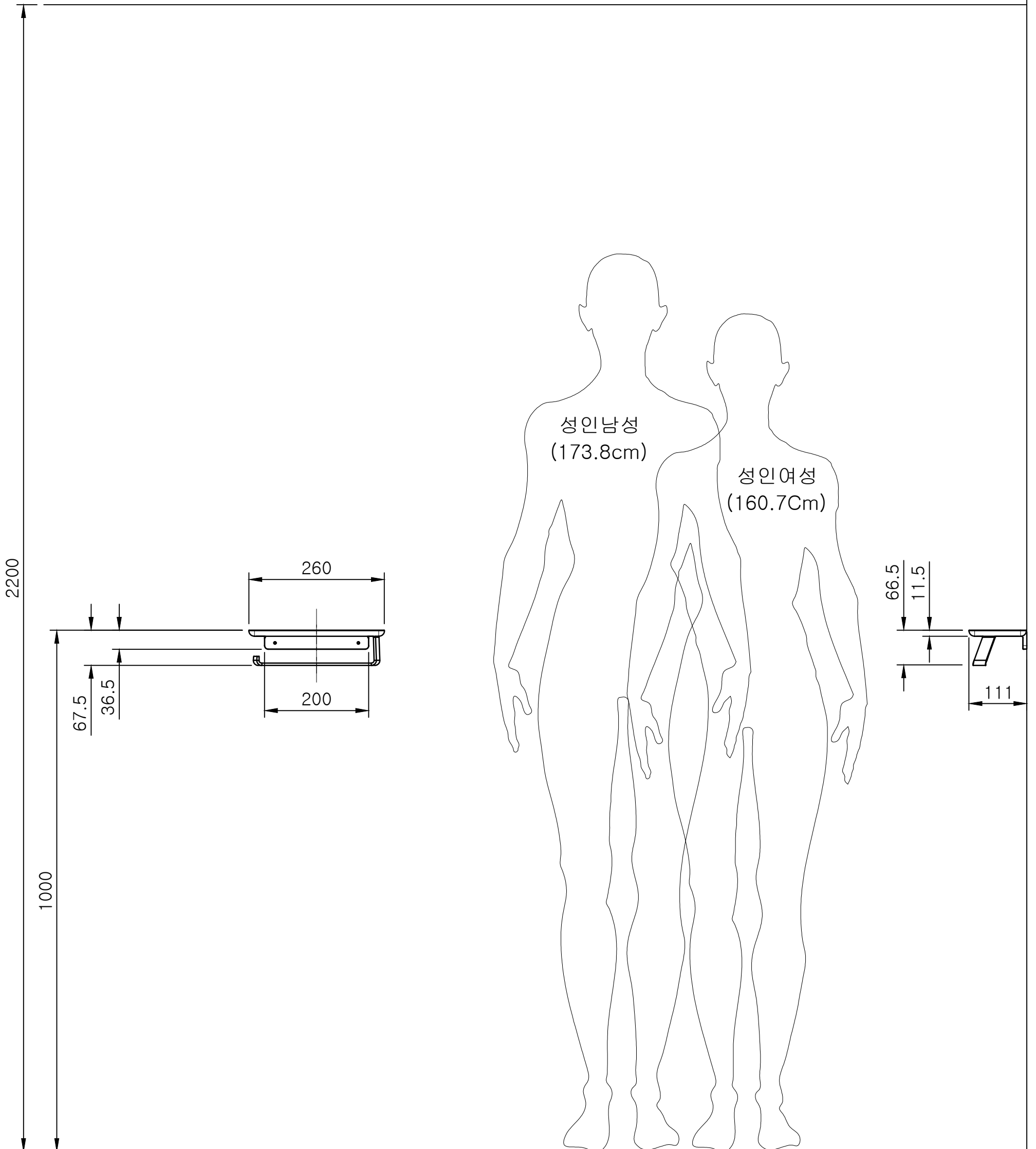

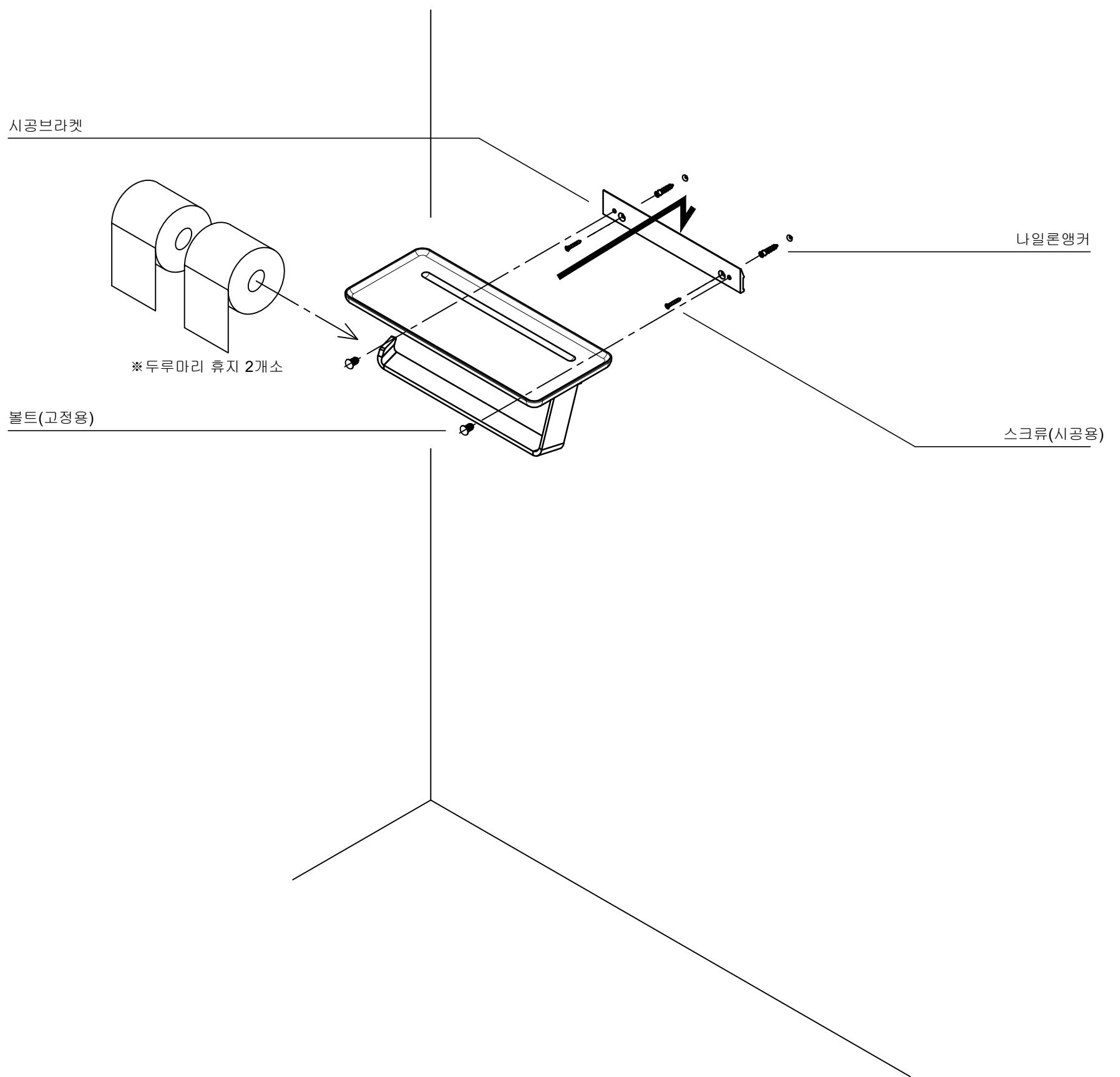

기본 설치도

Ø6 HOLE 타공

나일론앵커

시공브라켓

접시머리스크류

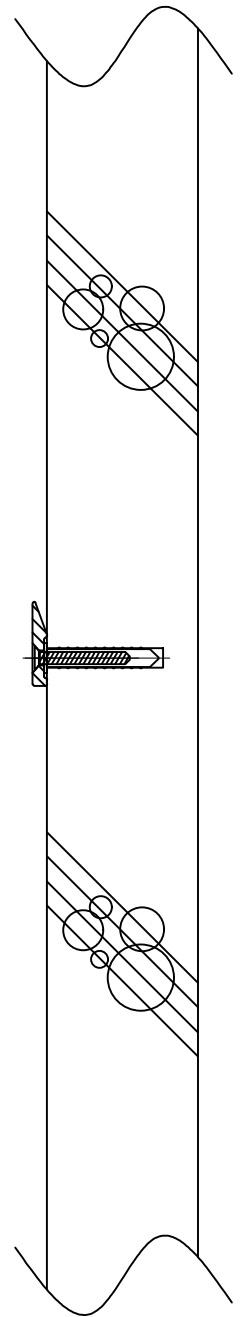
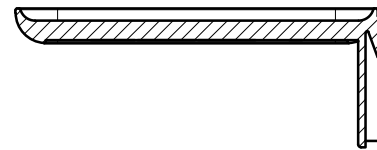
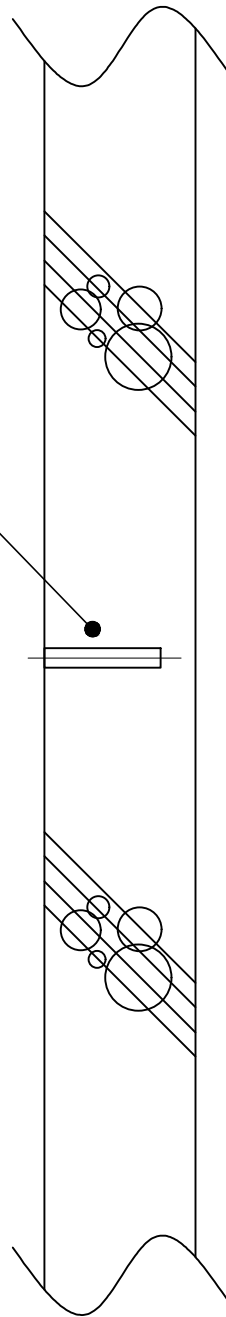

부품 리스트

◆ 부품리스트

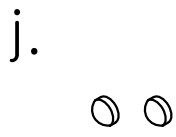
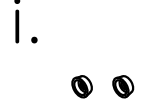
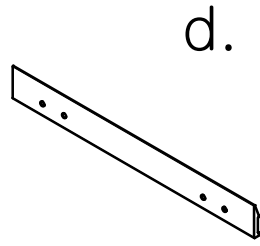
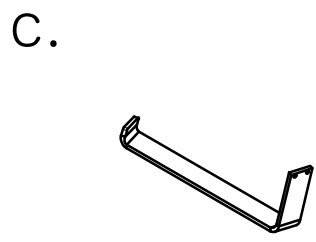
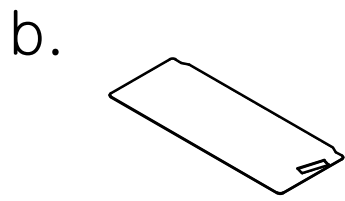
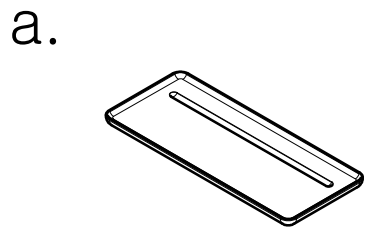

No.	리 슷 트	수 량
a	판넬	1
b	서스판넬	1
c	펜스	1
d	시공브라켓	1
e	시공스크류	2
f	나일론앵커	2
g	펜스브라켓	1
h	볼트(시공용)	2
i	캡인서트	2
j	디자인캡(화이트)	2

정측면도

